



DTOE-S606-1B

SMALL-CAPACITY ANALOG TRANSISTOR INVERTER

Juspeed-F™

S₂ SERIES

100V, 200V, 400V AND LOW NOISE SERIES
UP TO 10HP (7.5kW)

INSTRUCTION MANUAL

Before initial operation
read these instructions
thoroughly, and retain
for future reference

When properly installed, operated and maintained, this equipment will provide a lifetime of optimum operation. It is mandatory that the person who operates, inspects, and maintains this equipment thoroughly read and understand this manual.

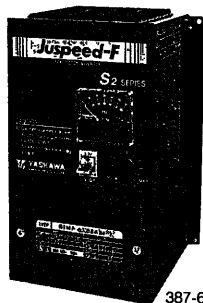

387-67

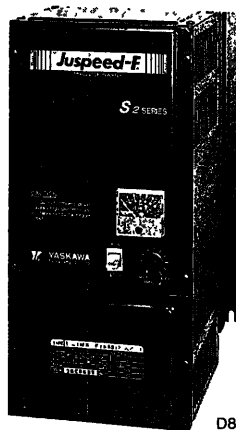

D89 S60-8

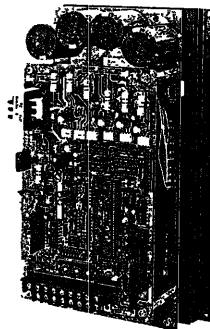

D89 S60-2

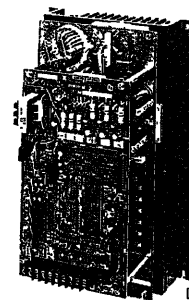

D89 S60-4

DANGER

- When using single-phase power supply, be sure to connect terminals to L1(R) and L2(S). Failure to observe this caution may result in rapid failure of the unit.
- Do not touch circuit components until CHARGE lamp extinguishes after turning off AC main circuit power. The capacitors are still charged and can be quite dangerous. Wait approximately five minutes after AC main circuit power is OFF.
- Do not connect or disconnect wires and connectors while AC power is applied.
- Do not check signals during operation.
- If Juspeed-F inverter protective circuit activates, inverter output is stopped and, motor is coasting. Take positive action to protect personnel and machines from damage caused by motor coasting. If used with brake motor, be sure that motor power supply is separate from braking power supply.

IMPORTANT

- Be sure to ground Juspeed-F using the ground terminal Ⓧ on the casing of Juspeed-F.
- Do not provide magnetic contactor (MC) or capacitor between Juspeed-F and motor.
- All the potentiometers of Juspeed-F have been adjusted and paint-locked at the factory. Do not change their settings unnecessarily.
- Do not perform the following tests in the field:
 - Withstand voltage test on any part of the Juspeed-F unit. It is an electronic device using semi-conductors and vulnerable to high-voltage.
 - Insulation resistance test with a megger. This test has been made at the factory and need not be conducted at test run. Exception: If megger-testing is required for inspection and maintenance purposes, it should be applied only to main circuit and the ground and never to the control circuit.
- Conduction test on control circuits.

RECEIVING

This Juspeed-F has been put through stringent tests at the factory before shipped. After unpacking, however, check and see the following.

- Nameplate ratings meet your requirements.
- Leads and connectors are not disengaged.
- No damage while in transit.
- Bolts and screws are not loose.

If any part of Juspeed-F is damaged or lost, immediately notify us giving full details and nameplate data.

Juspeed-F MAJOR CONTROL COMPONENT LAYOUT

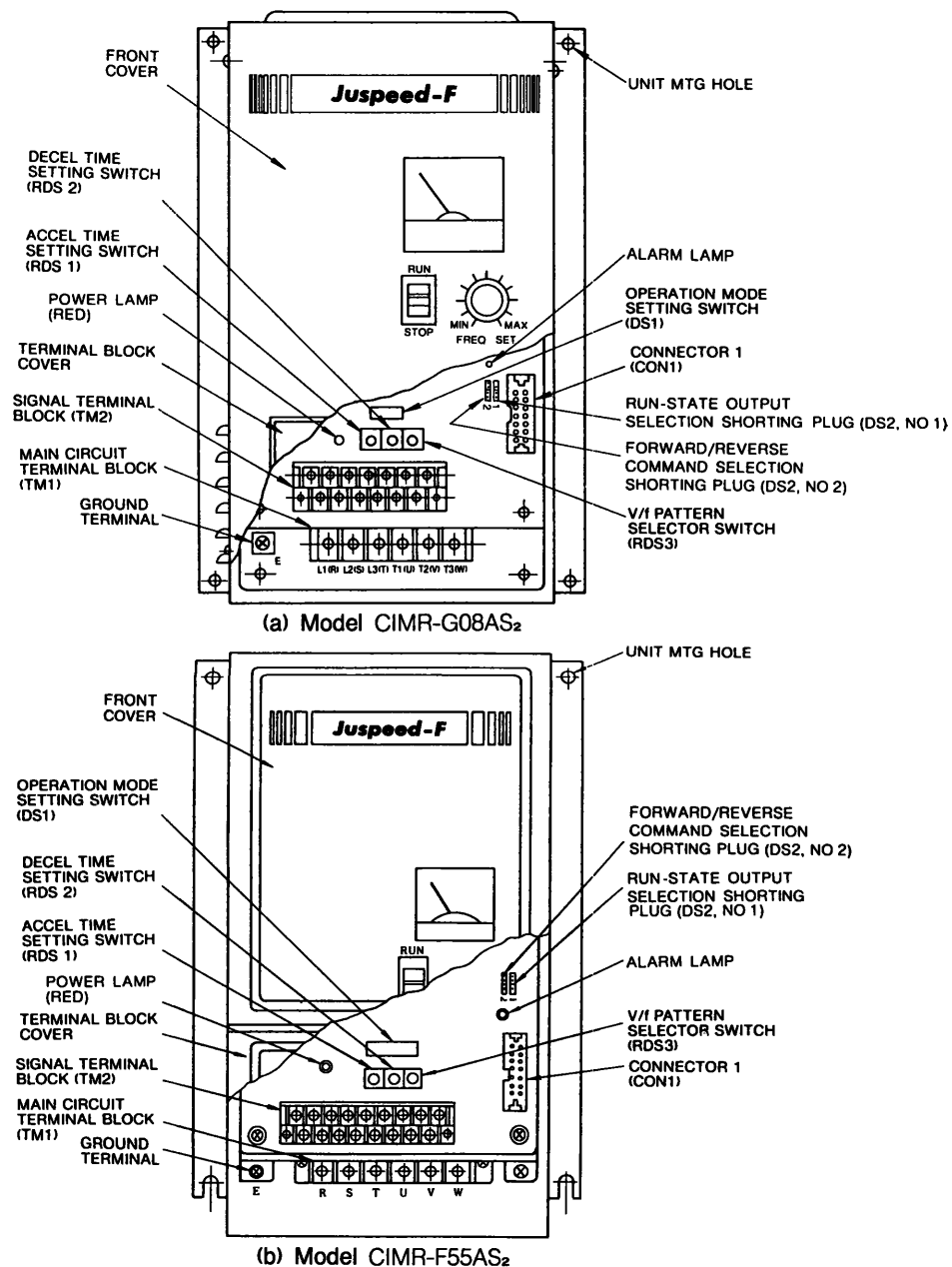

Fig. 1 Major Control Component Layout of Juspeed-F

INSTALLATION

LOCATION

Location of the equipment is important to achieve proper performance and normal operating life. The units should be installed in areas where the following conditions exist.

- Ambient temperature: -10 to $+40^{\circ}\text{C}$; -10 to $+50^{\circ}\text{C}$ with cover removed
- Protected from rain or moisture.
- Protected from direct sunlight.
- Protected from corrosive gases or liquids.
- Free from airborne dust or metallic particles.
- Free from vibration.

POSITIONING

For cooling and maintenance purposes, make sure that there is sufficient clearance around the equipment whether it is enclosed in a cabinet or not, as shown in Fig. 2. Keep 5 in. (12 cm) clearance between wiring duct and Juspeed-F also.

To maintain effective cooling conditions, it must be installed vertically to the ground so that product name can be read correctly using the four mounting screws.

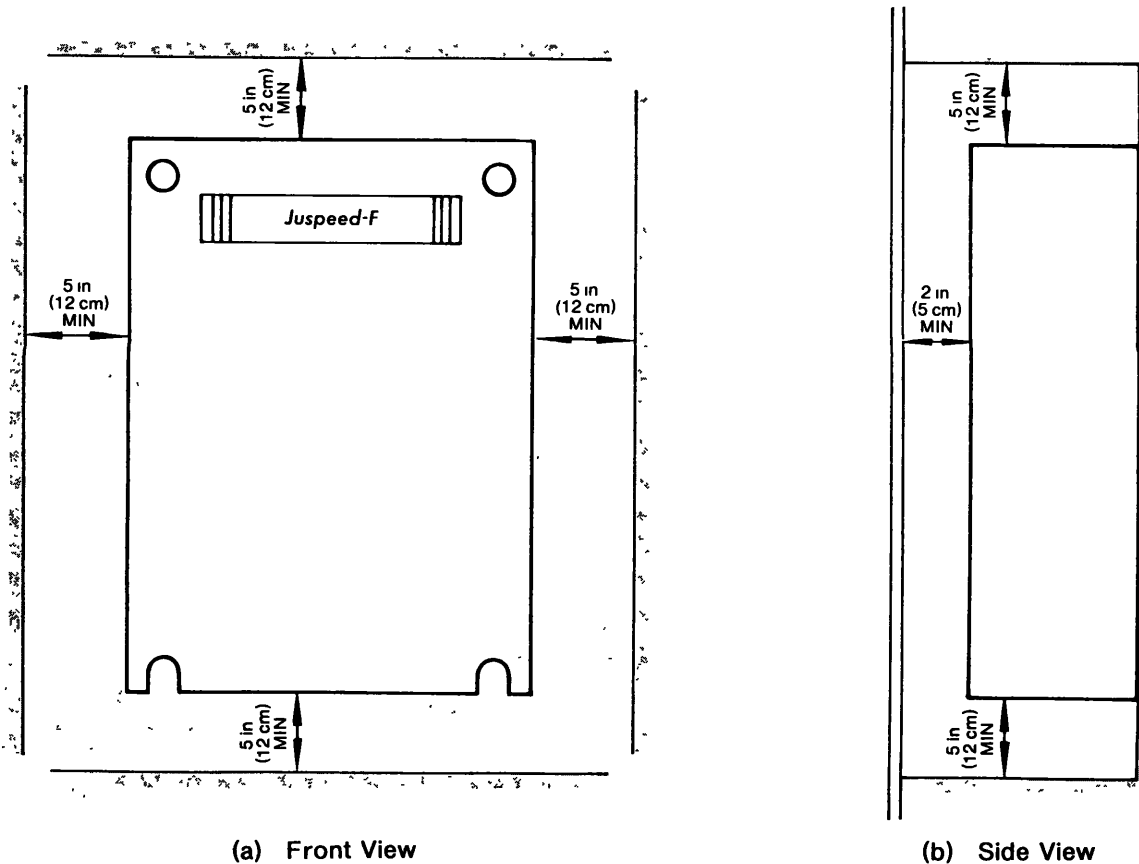

Fig. 2 Juspeed-F Clearance Requirements for Proper Cooling and Maintenance

WIRING

INTERCONNECTIONS

Fig.3 shows the connection diagram for Juspeed-F drive. Connections should be made correctly, referring to Fig.3. Before wiring, remove terminal block cover, run the leads through the lead entrance at the Juspeed-F bottom and connect them at the terminal block.

Wire size must be:

- 14 AWG (2 mm²) with M4 terminal screw for main circuit terminals ① (R), ② (S), ③ (T), ④ (U), ⑤ (V), ⑥ (W), and ⑦.
- 18 AWG (0.75 mm²) with M3 terminal screw for signal circuit terminals ⑧ to ⑬

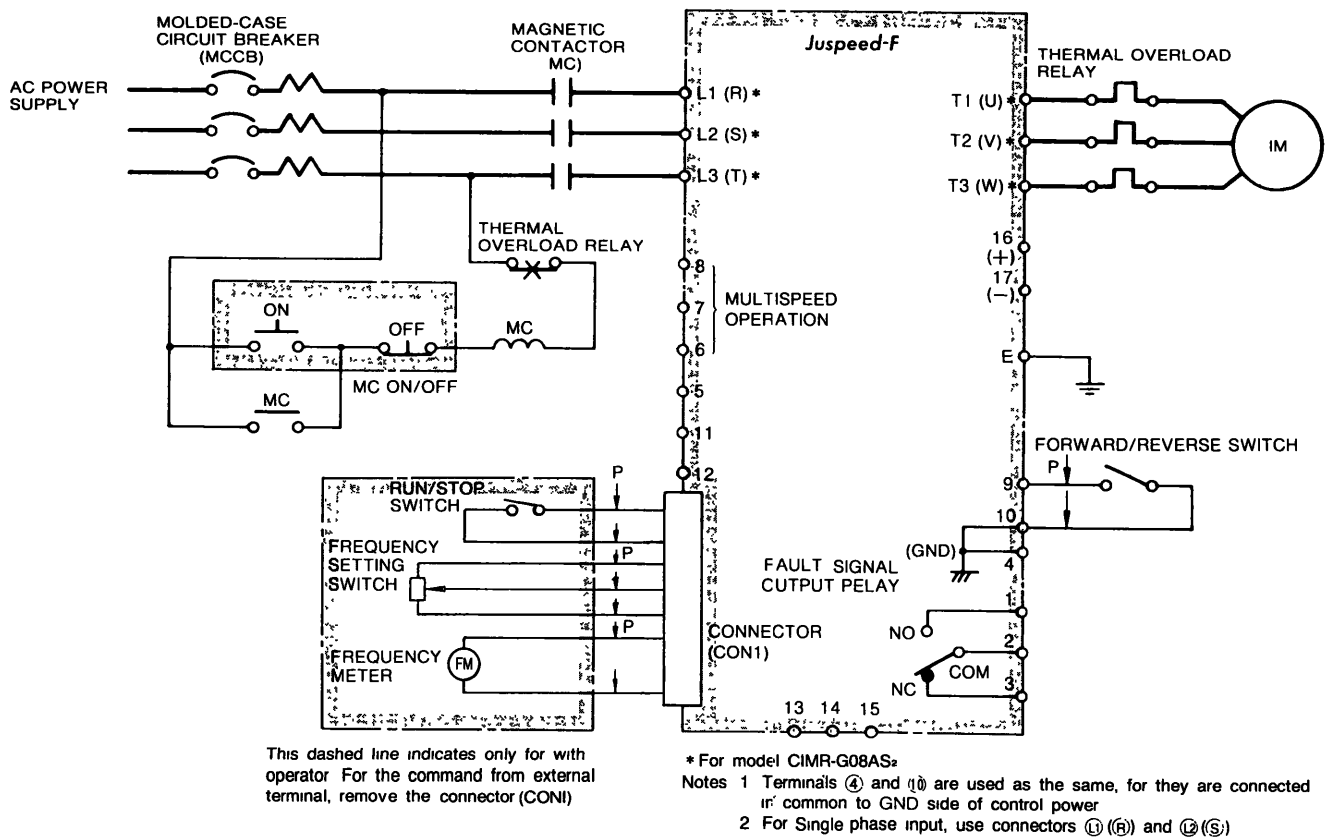

Fig. 3 Example of Juspeed-F Interconnections

Main Circuit Connections

(1) MOLDED CASE CIRCUIT BREAKER (MCCB) AND MAGNETIC CONTACTOR (MC)

Be sure to connect MCCBs rated 30AF, 10A between power supply and Juspeed-F input terminals ① (R), ② (S), ③ (T). To ensure safety, it is recommended that MC rated 250V, 10A or more containing a self-holding circuit be provided at power supply.

Do not connect MC between motor and Juspeed-F output terminals. Turning on or off the magnetic contactor flows full-voltage starting current into the controller and causes to Juspeed-F to stop. Frequent ON/OFF operations of MC may cause irreparable damage to Juspeed-F.

(2) Input terminals ① (R), ② (S), ③ (T), can be connected in any combination of power supply phase.

(3) Never connect AC power supply to output terminals T1 (U) , T2 (V) , T3 (W) . Failure to do so may cause irreparable damage to the controller.

(4) DIRECTION OF MOTOR ROTATION

When inverter output terminals T1 (U) , T2 (V) , and T3 (W) are connected to motor terminals T1 (U) , T2 (V) , T3 (W) , respectively, upon forward operation command, motor rotates forward.

(5) POWER FACTOR CORRECTION CAPACITOR

Never connect power factor correction capacitor between inverter output terminals T1 (U) , T2 (V) , T3 (W) , and motor.

Control Circuit Connections

(1) SIGNAL LEADS

Use the twisted lead for connections to signal terminals ④ to ⑭. The signal line must be separated from main circuit terminals T1 (U) , T2 (V) , T3 (W) , L1 (R) , L2 (S) , and L3 (T) and large current electrical circuit (400V, 200V, 100V relay sequence circuit). See Fig. 4. Lead length should be 66 feet (20 meters) or less.

Frequency setting switch is plugged-in by using JAE manual pressure tool CT150-1-PSSF. It employs JAE terminals 030-51304-001.

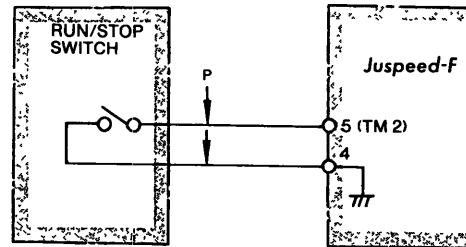

Fig. 4 Connections of RUN/STOP Switch

(2) USE WITH BRAKE MOTORS

When used with brake motors, power supply of brake must be separated from that of motor. Make a sequence so that brake engages after Juspeed-F main circuit is shut off. This provides positive motor stop when inverter protective circuit is shut off.

Grounding

Make a positive grounding using ground terminal ⑥ on the casing of Juspeed-F.

(1) Ground resistance should be 100Ω or less.

(2) Never ground Juspeed-F in common with welding machines, motors, and other large-current electrical equipment, or ground pole. Run the ground lead in a separate conduit from leads for large-current electrical equipment.

Molded-case Circuit Breaker (MCCB) and Power Supply Magnetic Contactor (MC)

Recommended MCCB and MC are listed below.

(1) 200V Series

Juspeed-F Model CIMR-		-04AS ₂ , -G04AS ₂	-08AS ₂ , -G08AS ₂	-15AS ₂ , -G15AS ₂	-22AS ₂ , -G22AS ₂	-37AS ₂ , -G37AS ₂
Molded-case Circuit Breaker (MCCB)		Model NF-30, 5A	Model NF-30, 10A	Model NF-30, 20A		Model NF-30, 30A
Magnetic Contactor (MC)		Model HI-7E	Model HI-7E	Model HI-10-2E/21A2		Model HI-20E/22A2
Main Circuit Terminals ① (R), ② (S), ③ (T), ④ (U), ⑤ (V), ⑥ (W)	Lead Size	2mm ²	2mm ²	35mm ²		35mm ²
	Terminal Screw	M 4				
Signal Terminals 1 to 17		Lead size 0.75mm ² or more, Terminal screw diameter M3				

(2) 400V Series

Juspeed-F Model CIMR-	-F04AS ₂	-F08AS ₂	-F15AS ₂	-F22AS ₂	-F37AS ₂	-F55AS ₂	-F75AS ₂
Molded-case Circuit Breaker (MCCB)	Model NF-30, 5A		Model NF-30, 10A		Model NF-30, 20A		Model NF-30, 30A
Magnetic Contactor (MC)	Model HI-7E		Model HI-10-2E		Model HI-20E		Model HI-30E
Main Circuit Terminals L (R), L (S), L (T), T (U), T (V), T (W)	Lead Size	2mm ²		3.5mm ²			5.5mm ²
	Terminal Screw	M4					
Signal Terminals 1 to 17	Lead size 0.75mm ² or more, Terminal screw diameter M3						

(3) 100V Series

Juspeed-F Model CIMR-	-J04AS ₂ -1	-J08AS ₂ -1
Molded-case Circuit Breaker (MCCB)	Model NF-30, 15A	Model NF-30, 15A
Magnetic Contactor (MC)	Model HI-10-2E	Model HI-15E
Main Circuit Terminals L (R), L (S), L (T), T (U), T (V), T (W)	Lead Size	2mm ²
	Terminal Screw	M4
Signal Terminals 1 to 17	Lead size 0.75mm ² or more, Terminal screw diameter M3	

(4) Low Noise Series

Juspeed-F Model CIMR-	-08AP-1	-22AP-1	
Molded-case Circuit Breaker (MCCB)	Model NF-30, 10A	Model NF-30, 20A	
Magnetic Contactor (MC)	Model HI-7E	Model HI-10-2E	
Main Circuit Terminals L (R), L (S), L (T), T (U), T (V), T (W)	Lead Size	2mm ²	3.5mm ²
	Terminal Screw	M4	
Signal Terminals 1 to 17	Lead size 0.75mm ² or more, Terminal screw diameter M3		

<p>CAUTIONS: INSERT SURGE ABSORBERS TO THE COILS OF MAGNETIC CONTACTORS, CONTROL RELAYS, MAGNETIC VALVES, AND MAGNETIC BRAKES.</p>

TEST RUN

CHECKS BEFORE TEST RUN

After completing mounting and connection of units, check for:

- Correct connections
- No short-circuit conditions
- No loose screws (Check especially for loose wire clippings)
- Proper load conditions
- Correct input power (No voltage drop or voltage imbalance, power supply capacity: 3kVA or more)

PRESETTING AND ADJUSTMENT

Operation Mode Setting Switch

Operation mode setting switch (DS1) consists of six ON/OFF slide switches printed on a base board. Select the operation modes from Table 1 according to the application. All the ON/OFF slide switches have been preset at factory to OFF as shown in Fig.5.

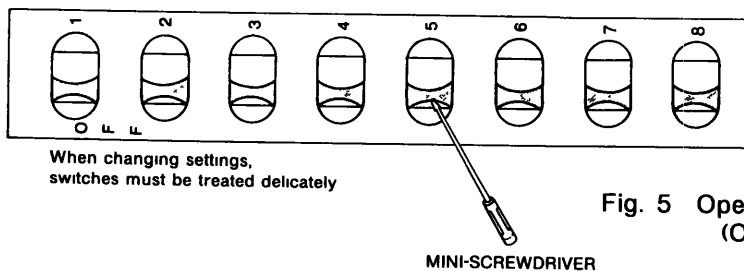

Fig. 5 Operation Mode Setting Switch (DS1)
(ON/OFF Slide Switches)

Table 1 Selection of Operation Modes

Slide Switch No.	Setting	ON/OFF	Operation Mode
1	Stopping mode	ON	Coasts to a stop
		OFF	Brakes to a stop
2	Offset selection	ON	Provided. (Under 1 to 5V, 4 to 20mA command, frequency) becomes up from 1V, 4mA
		OFF	Not provided.
3 or 4*	High-speed frequency limit	3: ON 4: OFF	50 Hz
		3: OFF 4: OFF	60 Hz
		3: OFF 4: ON	90 Hz
		3: ON 4: ON	120 Hz
5	Running/ stopping	ON	Runs at frequency reference of 5Hz or above Stops at frequency reference of less than 5Hz
		OFF	Runs at 5Hz with frequency reference of 0 or 5Hz.
6	Rapid stop	ON	Stops rapidly in approx 0.2s with stop command.
		OFF	Brakes to a stop in the time set by RDS 2.
7 or 8*	-	3: OFF 4: OFF 7: OFF 8: OFF	Frequency set by frequency setting potentiometer 10kΩ or 0 to 10 VDC signal.
		7: OFF 8: ON	Frequency set by 1 to 5 VDC signal.
		7: ON 8: OFF	Frequency set by 4 to 20 mA DC signal.
		7: ON 8: ON	Frequency setting input is not used.

*③ and ④, and ⑦ and ⑧ must be set in combination, respectively

† Frequency initiates from 1 V (1 to 5 V reference) or 4 mA (4 to 20 mA reference).

Forward/Reverse Command and Run-State Output Selection Switch

Table 2 Selection of Forward/Reverse Command and Run-State Output

Switch No.	Mode	Shorting Plug	Description of Operation
DS2	2	Forward/Reverse Command Selection	Upper (Operation and forward/reverse commands are controlled.)
			Lower (Forward/reverse command.)
	1	Run-State Output Selection	Upper (Frequency synchronization signal Output.)
			Lower (Output during operation)

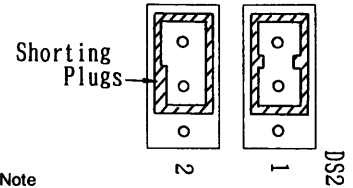

Note
Use pliers or pincette for changing shorting plugs

Fig. 6
Forward/Reverse Command and Run-state Output selection Switch (DS2)

The shorting plug is set in the upper mode as illustrated prior to the Juspeed-F being shipped from the factory.

(1) Forward/Reverse Command Selection Switch

The forward or reverse command mode can be selected by setting Mode A or B as shown below.

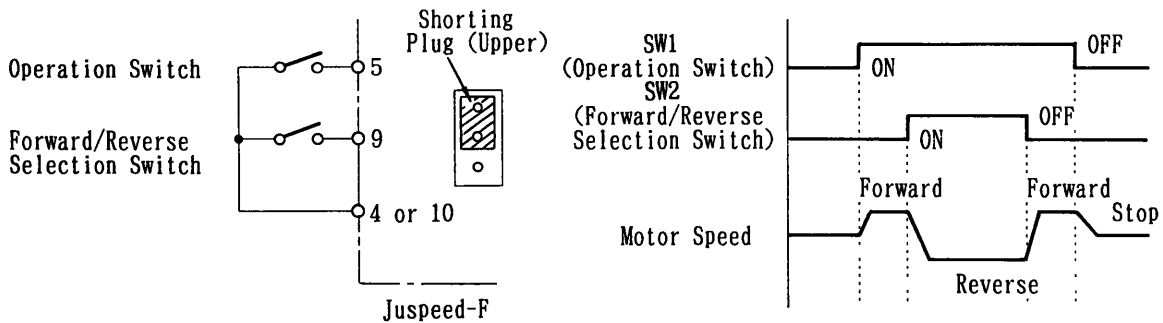

Mode A: Selection of forward and reverse operation can be controlled by combining the operation signal and forward/reverse signal.

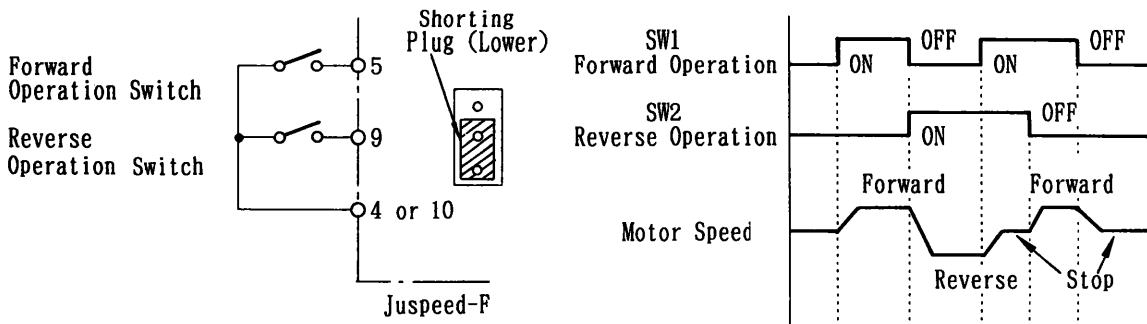

Mode B: Selection of forward and reverse operation can be controlled by the forward and reverse signals. The motor stops if both the forward and reverse operation signals are input simultaneously.

(2) Run-state output selection

The switch to select the frequency synchronization signal output or output during operation. Use the terminal box (TM2 (12)) or the connector (CON1 (17)) for signal output. The output signal is output by the open collector.
(Vcc max = 35V, Ic max = 50mA)

Acceleration/Deceleration Time Setting Switch(RDS1)

Set the acceleration and deceleration times using accel/decel time setting switches (RDS1, RDS2) according to applications and load conditions. Table 3 shows the settings of RDS1 and RDS2 notches, acceleration and deceleration time and DC injection braking time at maximum frequency of 60 Hz (or 120 Hz). The switches have been preset at the factory to notch ③. High-speed frequency limit of 90 Hz or 120 Hz is selected, the time ranges in Table 3 are 0 to 120 Hz or 120 to 0 Hz.

Acceleration time and deceleration time RDS1 and RDS2. Acceleration and deceleration times represent the range of time of output frequency from 0 Hz to 60 Hz (or 120 Hz) and 60 Hz (or 120Hz) to DC injection braking, respectively. Calculate the corresponding time from the formula:

$$\text{Accel/decel time to be set} = \text{Time in Table 3} = \frac{\text{Max Frequency}}{60 \text{ (or 120)}}$$

Example

At maximum output frequency of 50Hz or 90Hz, the following calculation will apply.

$$\text{At 50 Hz, accel/decel time to be set} = \frac{\text{Accel/decel time in Table 3}}{60} \times \frac{50}{60}$$

$$\text{At 90 Hz, accel/decel time to be set} = \frac{\text{Accel/decel time in Table 3}}{120} \times \frac{90}{120}$$

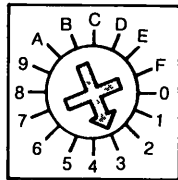

RDS1: Accel Time Setting Switch
RDS2: Decel Time Setting Switch

Table 3 Accel/Decel Times and DC Injection Braking Time at Switch Notches

Notch	①	②	③	④	⑤	⑥	⑦	⑧	⑨	A	B	C	D	E	F
Accel/Decel Time (s)	0.35	0.50	0.75	1.00	1.50	2.00	2.50	3.00	3.30	3.80	4.40	5.30	6.50	8.60	26
DC Injection Braking Time(s)	0.09	0.10	0.11	0.12	0.13	0.15	0.16	0.19	0.21	0.25	0.30	0.37	0.50	0.75	3.00

V/f Pattern Selector Switch

V/f pattern selector switch (RDS3) sets the voltage corresponding to the output frequency. For smooth motor running, select the optimum V/f pattern from 10 types listed in Table 4. The V/f pattern selector switch has been preset at the factory at notch ①. Setting excessively high voltage at low frequency may cause overcurrent and result in activating overcurrent protective function to shut off the transistor power.

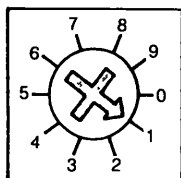

V/f Pattern Selector Switch (RDS3)

V/f Pattern Selector Switch (Cont'd)

Table 4 Nine Types of V/f Patterns

Application	Hz	V/f Pattern	Application	Hz	V/f Pattern
General Purpose (Start at 50% torque of the rating)	50 Hz		High-start Torque (Start at more than 100% torque of the rating)	50 Hz	
	60 Hz			60 Hz	
	90 Hz or 120 Hz		Fans and Pumps (At variable torque)	50/60 Hz	

Note

1 Circled numbers in the table above indicate the notch to be set by the V/f pattern selector switch and their respective pattern curve

V/f Pattern Selection

Table 5 V/f Pattern Selection

Pattern Notch No.	Selection
0 (at 60 Hz) 4 (at 50 Hz)	For high starting torque of 150% rated torque. Apply to next upper inverter capacity; combination with motor output for inverters may activate overvoltage protective circuit. Use a special motor. Continuous operation of standard motors at low frequency cannot be made.
1 (at 60Hz) 5 (at 50Hz)	For starting torque of 100% rated torque. Optimum for constant torque such as conveyors. Continuous operation of standard motors at low frequency cannot be made. Use a special motor.
2 (at 60Hz) 6 (at 50Hz)	For starting at 50% of the rated torque. For the application requiring 50% starting torque or less, noise and vibration at low frequency will be reduced as compared with 100% rated starting torque mode of pattern ① and ⑤.
3(at 60Hz) 7(at 50Hz)	For variable torque loads specially for fans and pumps.
8(at 90Hz) 9(at 120Hz)	For high-frequency motor at 90 Hz or 120 Hz.

Note: Operation of standard motor at 60 Hz or more may cause motor vibration or cooling fan noise. Use of special motor is recommended.

Signal Connections

Signals can be connected through terminal block (TM2) or connector receptacle (CON1). Tables 6 and 7 list the functions of terminal block (TM2) and connector receptacle (CON1), respectively.

Table 6 Terminal Block TM2 Function

Terminal No.	Terminal Name	Terminal Function
1	Fault Signal	Contact signal output indicating that inverter protective circuit activates and operation stops.
2		
3		
4	I/O Common	Common terminals for I/O terminals 5 to 12. (Zero volt terminal of control circuit: GND)
10		
5	Operation or Forward Operation	Contact signal for operation/stop or for forward operation (for 2-3 shorting at switch No. 2 of DS2). Connected to Terminal 4 or 10. (ON: Operation or forward operation, OFF: stop)
6	Multispeed Operation Input	Input for multispeed operation. "L" for activation.
7		
8		
9	Forward/Reverse Changing or Reverse Operation	For contact signal of forward/reverse or reverse operation (during 2-3 shorting at switch No. 2 of DS2). Connected to Terminal 4 or 10.
11	For Resetting Input	Resetting input during inverter tripping and connected to Terminal 4 or 10. (ON: Reset)
12	Frequency Synchronization Output signal (For upper position of switch no. 1 shorting plug of DS2)	Open collector output terminal which indicates that output frequency reaches the set frequency. ("L"-when synchronized, "H"-in other cases)
	Output During Run (For lower position of switch no. 1 shorting plug of DS2)	Open collector output terminal which indicates the running. ("L"-during run, "H"-in other cases)

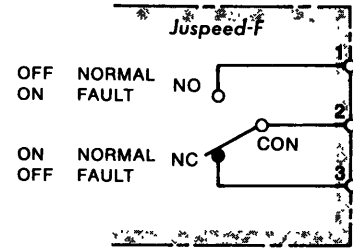

Signal Connections (Cont'd)

Table 6 Terminal Block TM2 Function (Cont'd)

Terminal No.	Terminal Name	Terminal Function
13	Frequency Setting	0 V of control circuit. Connected to minus (-) of 0 to 10 V, 1 to 5V, and 4 to 20 mA.
14	Frequency Setting Input	Inputs plus (+) signals of 0 to 10 V, 1 to 5V, and 4 to 20 mA. For frequency setting potentiometer, connect to terminal 2 (center pin).
15	Frequency Setting Power Output	Used as power supply for setting by use of frequency setting potentiometer (10 k Ω)
16	Frequency Meter Driving (Output)	Connects to frequency meter (1 mA DC at 60, 120Hz). (Plus of terminal 16, minus of terminal 17). Use moving coil type DC ammeter for frequency meter.
17		

Notes:

1. Input open collector signal with terminals 4 and 10 as common (GND common) for each input terminal. To input contact signal, input no-voltage contact signal between terminals 4 and 10. "Closed" means "L" of open collector.
2. Internal wiring of TM2 and CON1:
Both terminals TM2 and CON1 with same function are directly connected internally, therefore use either one of them.
For standard models with operation pannel, the connector is applied to CON1, so TM2 terminal with same function is not available.

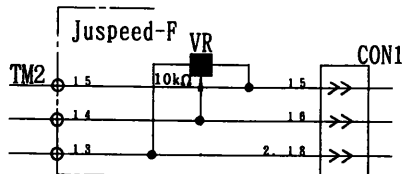

Interconnection of TM2 and CON1

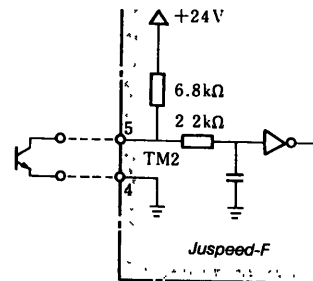

Open-Collector Input Terminal Interconnection

Signal Connections (Cont'd)

Table 7 CON1 Connector Function

Pin No.	Pin Name	Connector Function
1	NC	Spare Pin
2, 18	I/O Common	0 V of control circuit (GND)
3	Fault Signal	Open collector signal output indicating that inverter protective circuit activates and operation stops. "L" at stop by fault, "H" in other cases. Vcc=35V max Ic=50mA max
4	Operation or Forward Operation Input	For input of operation/stop or forward operation (during 2-3 shorting at switch No.2 of DS2) command. Connected to Terminal 2 or 18. (ON: Operation or forward operation, OFF: stop)
5	Multispeed Operation	Input for multispeed operation. Activates at "L."
6		
7		
8	Forward/Reverse Changing or Reverse Operation Input	For input of forward/reverse changing or reverse operation (during 2-3 shorting at switch No.2 of DS2) command. Connected to Terminal 2 or 18.
9	For Resetting Input	Resetting input during inverter tripping and connected to Terminal 2 or 18. (ON: Reset)
10 to 14	NC	—
15	Frequency Setting Power Output	Used as power supply for setting by use of frequency setting potentiometer.
16	Frequency Setting Power Input	Inputs plus (+) signals of 0 to 10 V, 1 to 5 V, and 4 to 20 mA. For frequency setting potentiometer, connect to terminal 2 (center pin).
17	Frequency Synchronization Output signal (For upper position of switch no.1 shorting plug of DS2)	Open collector output terminal which indicates that output frequency reaches the set frequency. ("L"-when synchronized, "H"-in other cases)
	Output During Run (For lower position of switch no.1 shorting plug of DS2)	Open collector output terminal which indicates the running ("L"-during run, "H"-in other cases)
19	Frequency Meter	Connect a frequency meter, 1 mA DC at 60 or 120 Hz (pin 19 at "+" and pin 20 at "-"). Use a moving coil type DC ammeter as a frequency. (e.g. Model TRM-45G made by KUWANO Electric) meter.
20		

Note : Input open collector signal with input pins 2 and 18 as common (GND common) for each input pin. To input contact signal, input contact signal between pins 2 and 18.
"Closed" means open collector "L".

Location of CON1 Connector Pins

Pin header (receptacle) is mounted on the PC board. Mount terminals according to connector pin numbers. Plug the connector firmly into the pin header.

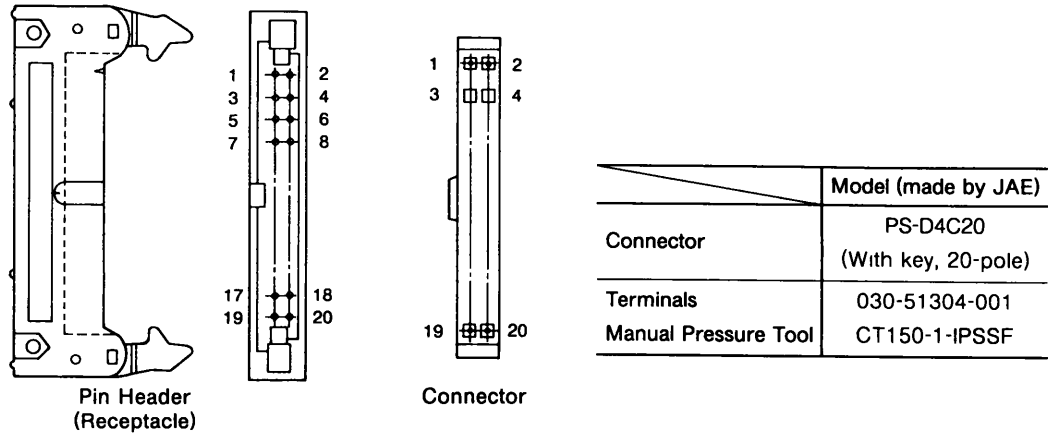

Fig. 6 CON 1 Connector Pins

Fault Signal Terminals ①, ②, ③

Give the contact output if the inverter is tripped.

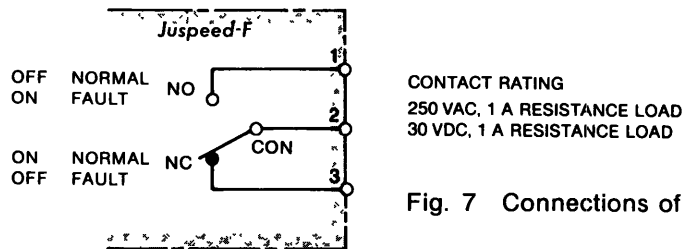
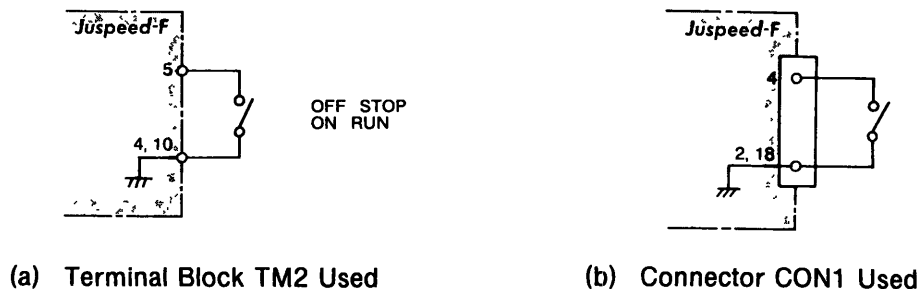

Fig. 7 Connections of Fault Signal Output Relay

RUN/STOP or Forward Operation Terminals (⑤ and ④ or ⑤ and ⑩)

Terminals for motor run/stop switch are connected as shown in Fig.8.

For remote running or stopping of motor, use a toggle switch (30 VDC, 3A, contact resistance: 0.010Ω or less) and connect with twisted lead to prevent erroneous operation due to noise. Terminals ④ and ⑩ are connected within the circuit. RUN/STOP or forward operation can be selected by shorting plug position at switch No.2 of DS2.



NOTE

When TM2 and CON1 are used at the same time, if signal of either one is low, the other one will not be activated by turning ON or OFF.

Fig. 8 Connections of RUN/STOP or Forward Operation Switch

Forward/Reverse or Reverse Operation Terminals (⑨ and ④, or ⑨ and ⑩)

Terminals for motor forward/reverse or reverse operation switch. See Fig.9. Motor runs forward by turning off terminals ⑨ and ④ and reverses by turning them on. If mode B (shorting plug is in lower position) is selected at switch No.2 of DS2, reverse operation is commanded. Use a toggle switch (30 VAC, 3A, contact resistance: 0.010Ω or less) or equivalent.

Forward/reverse running can be changed during operation. For forward operation only, forward/reverse switch need not be connected.



(a) Terminal Block TM2 Used

(b) Connector CON1 Used

Note) At the selection of forward/reverse individual operation command mode (shorting plug is in lower position), if forward and reverse commands are simultaneously executed, inverter output becomes "0" zero.

Fig. 9 Connections of Forward/Reverse or Reverse Operation Switch

Multispeed/ Terminals (⑥, ⑦, ⑧, ④ or ⑩)

Terminals for contact input for multispeed. See Fig. 10.

Set ON or OFF of the external switches corresponding to output frequency in Table 8.

Use the relay or switch with high reliable contact for micro current.

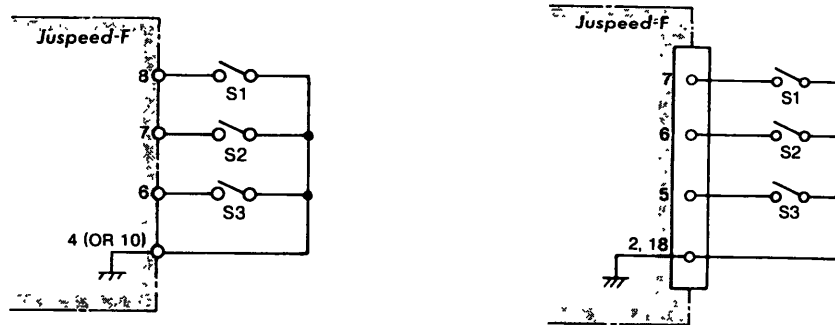

(a) Terminal Block TM2 Used

(b) Connector CON1 Used

Fig. 10 Connections of External ON/OFF Switches for Multispeed Operation

Table 8 Setting of External Switches

External ON/OFF Switch			Operation Mode	Multispeed
S1	S2	S3		Output Frequency
OFF	OFF	OFF		Frequency set by frequency selector
OFF	OFF	ON		5Hz
OFF	ON	OFF		10Hz
OFF	ON	ON		20Hz
ON	OFF	OFF		30Hz
ON	OFF	ON		40Hz
ON	ON	OFF		50Hz
ON	ON	ON		60Hz

TEST RUN

Uncouple the motor from the driven machine to insure safety. Start the operation following the procedures below.

1. Move RUN/STOP switch to STOP. Turn off the external sequence switches, if used.
2. Set the frequency setting switch to 5 Hz or below. When the frequency set by the switch is between 0 to 5 Hz, 5 Hz command is given and motor rotates at 5 Hz when the RUN/STOP switch is set to RUN. When operation mode setting switch (DS1) notch 5 is set to ON, frequency reference of less than 5 Hz is given as 0 speed reference and motor stops.
3. Turn on Juspeed-F molded case circuit breaker (MCCB) and then the magnetic contactor (MC). At this time, motor still does not start unless the operation circuit malfunctions. Check the motor for any noise or vibration (by hand) to make sure no malfunction has occurred.
4. Change RUN/STOP switch to RUN. Make sure that the motor is running forward. If shaft rotation is incorrect, change FORWARD/REVERSE switch to REVERSE or reverse any two of motor leads ① (U), ② (V), ③ (W).
5. Juspeed-F output frequency increases or decreases according to the preset accel/decel time. Motor accelerates or decelerates according to the frequency as well. If the motor does not run smoothly during acceleration or deceleration, or Juspeed-F stops due to malfunction, the accel/decel time is assumed to have been set too short for the load level.
6. Accel/decel time and V/f pattern can not be changed during motor operation. The change must be carried out at operation command off. See pars. 'Setting of Acceleration and Deceleration Times' and 'Selection of V/f pattern.'

TEST RUN

7. If any of the protective functions activates, Juspeed-F is stopped. Turn off the AC main circuit power by turning off the molded case circuit breaker (MCCB) or magnetic contactor (MC) and turn on the power again.

Trouble can be located by the blinking fault lamp (milk-white) on the lower part of the printed board. If Juspeed-F stops, remove the terminal board cover and identify the trouble with the blinking lamp, referring to Table 9.

8. If load inertia (WK^2) is excessively large, rapid acceleration or deceleration frequently occurs, motor stops due to overvoltage (OV: overvoltage). In such cases or braking discharge resistor may be tripped. Should this happen, contact your Yaskawa representative.

OPERATION

After the test run is over, start the operation keeping the following in mind.

- (1) For general purpose motors combined with Juspeed-F controller, motor temperature rises noise and vibration increase as compared with commercial power.
- (2) Operate the motor at the temperature below the allowable temperature rise level, for motor cooling effects decrease at low speed operation.
- (3) Motor ratings
 - When two or more motors are controlled by a single Juspeed-F, check to be sure that the total motor current is not larger than the inverter rating.
 - When multipole motors of more than 8 poles or special purpose motors are used, make sure that motor current is within the inverter rating.
 - Even with small load, never use a motor whose current exceeds the inverter rating.
- (4) Never connect a capacitor at the inverter output, for it may cause activation of overcurrent protective function.
- (5) To start and stop the motor, use RUN/STOP switch on the front of Juspeed-F, not the magnetic contactor (MC) or molded case circuit breaker (MCCB) which are used only for emergency stop.
- (6) If supply voltage changes at momentary power failure, protective functions may operate and stop Juspeed-F, resulting in motor coasting to a stop. Turning on the AC power supply within one second after the activation of protective functions will not restart the motor. Power input after approximately 10 seconds will restart the motor. For the application requiring positive motor stop in an emergency, provide magnetic contactor (MC) including self-holding circuit at power input as shown in Fig. 3.
- (7) Restart the motor after making sure that the motor has come to a full stop. If the operation is started during motor coasting, overcurrent protective function may be activated.

MAINTENANCE

Juspeed-F requires almost no routine checks. It will function efficiently and longer if it is kept clean, cool and dry, observing precautions listed under "Location." Especially check for tightness of electrical connections, discoloration or other signs of overheating. When servicing inspection, turn off AC main circuit power and wait ten minutes before removing the terminal cover. The capacitors are still charged and can be quite dangerous.

Insulation Resistance Test

- For megger-testing the external circuit, remove all the Juspeed-F terminals and do not apply the test voltage to the inverter.
- For megger-testing the inverter, measure the insulation resistance of the main circuit only with a 500 VDC megger.

Connect the AC main circuit terminals L1 (R) , L2 (S) , L3 (T) , T1 (U) , T2 (V) , and T3 (W) by a common wire as shown in Fig. 12. After that, measure the insulation resistance between the common wire and ground with a megger. If reading is above $1\text{M}\Omega$, it is considered satisfactory. Never measure the insulation resistance of the control circuit.

- Never make a conduction test of the control circuit.

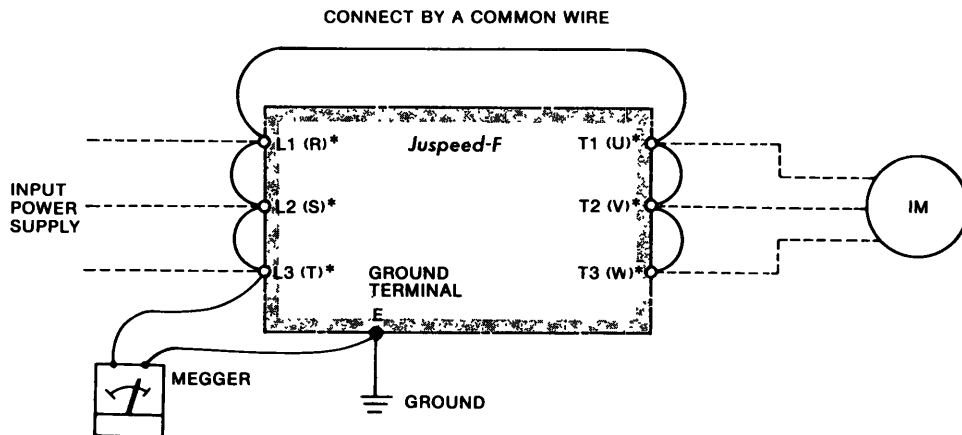
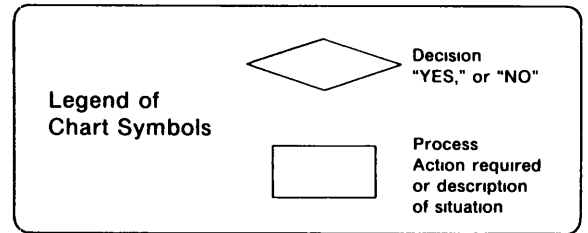

Fig. 11 Connections for Megger-testing

TROUBLESHOOTING

If Juspeed-F malfunctions, find the cause and take the corrective actions by following the flowcharts given in Figs. 12 to Fig. 14.

If the causes cannot still be located by the flowcharts, the inverter or some parts are damaged, or any other problem occurs, contact Yaskawa representative.



(1) Motor will not run

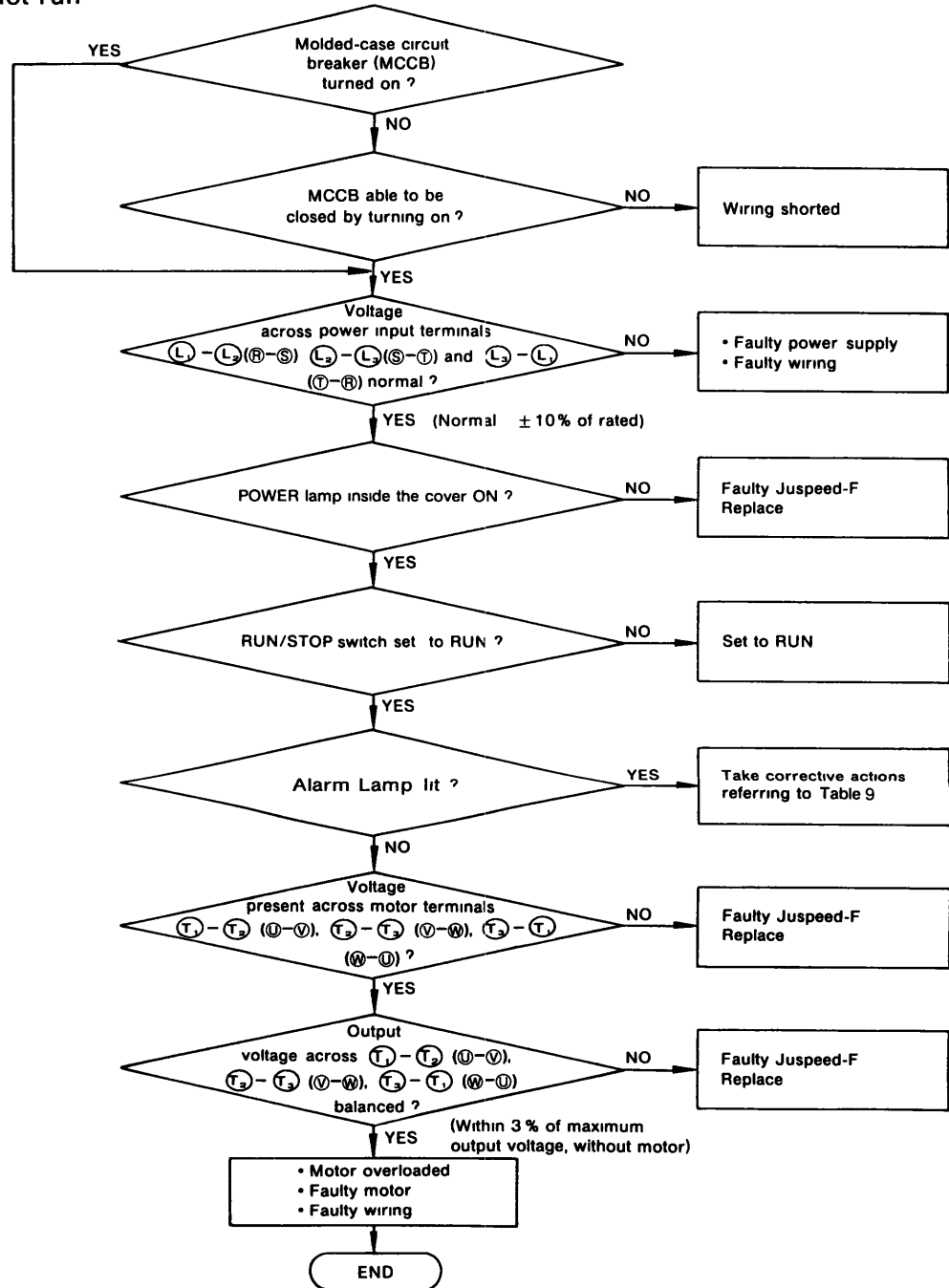

Fig. 12 Motor will not Run

TROUBLESHOOTING (Cont'd)

(2) Motor overheat

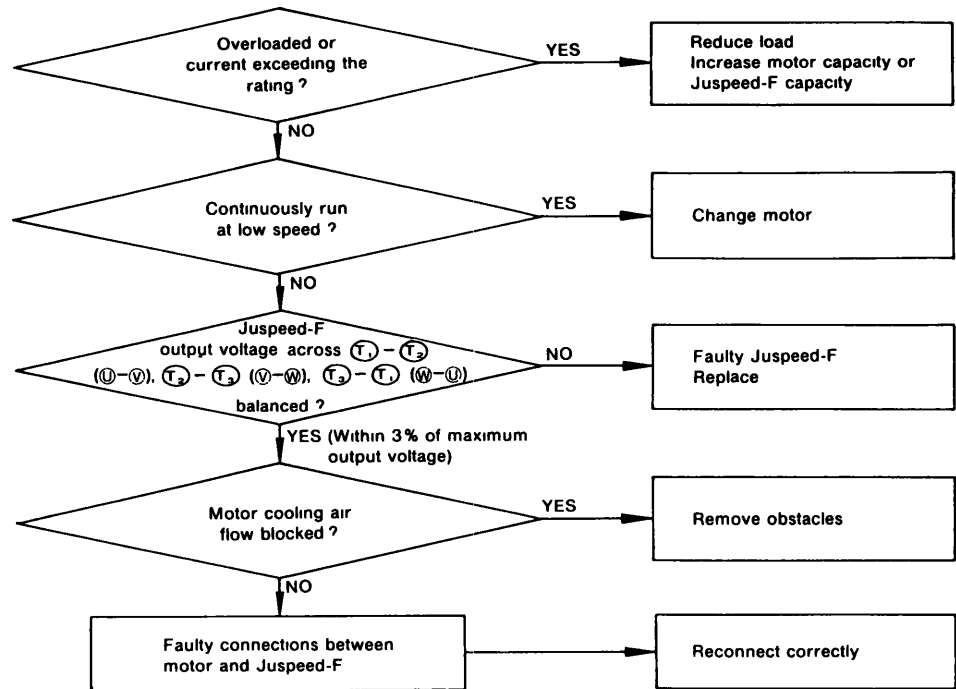

Fig. 13 Motor Overheat

(3) Motor hunting

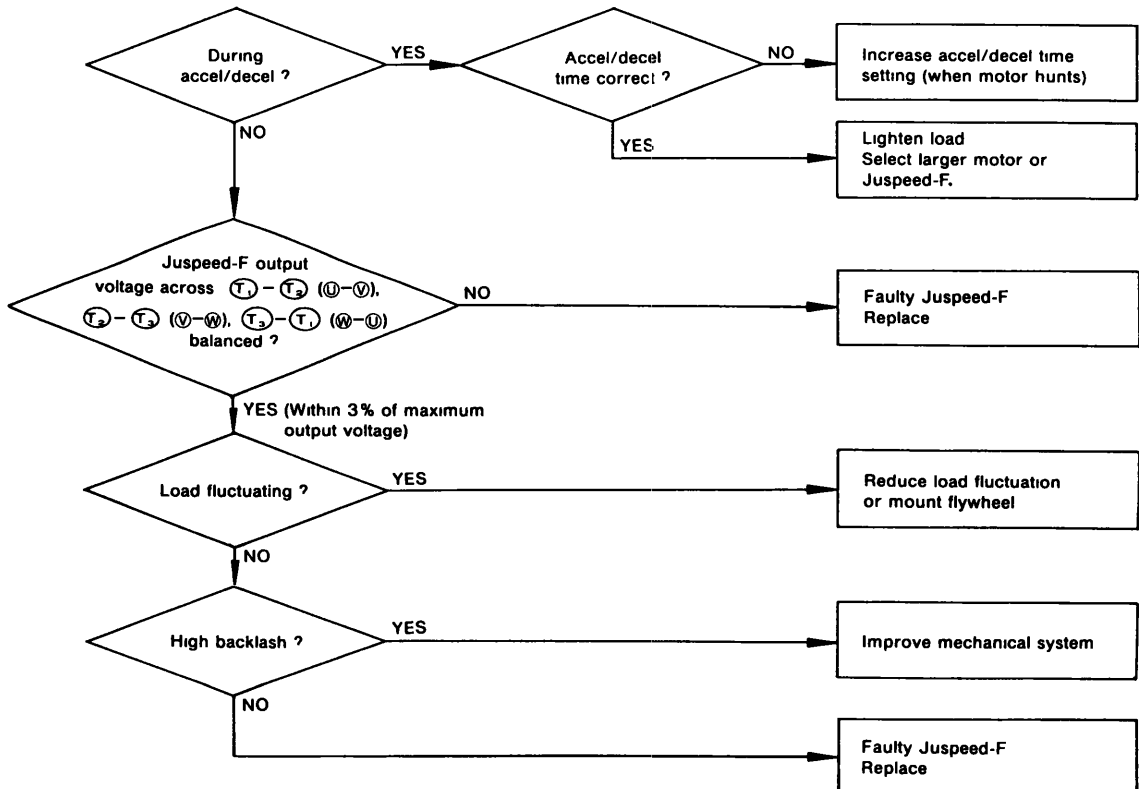
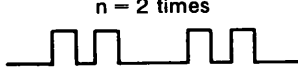
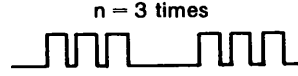
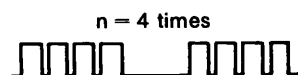
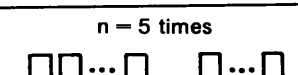
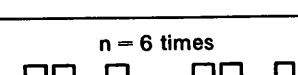

Fig. 14 Motor Hunting

CAUSES FOR BUZZER AND FAULT LAMP ACTIVATION AND REMEDIAL ACTIONS

If Juspeed-F malfunctions, fault lamp (milk-white) lights. Depending on the type of malfunction, the lamp will blink. When the lamp blinks, check for continuous or intermittent blink and whether the operation switch is ON or OFF.

Table 9 Failure Indication of Juspeed-F

Operation of Fault Lamp	Cause	How to Check	What to Do
	Instantaneous overcurrent protection		
 <p>n = 2 times</p>	<ul style="list-style-type: none"> Juspeed-F output circuit shorted or ground fault 	<ul style="list-style-type: none"> Remove Juspeed-F output terminals and measure the resistance across motor leads or motor leads and ground. Use an ohmmeter across motor leads, and a megger across any one of motor lead and ground. 	<ul style="list-style-type: none"> If less than $1M\Omega$, correct the short-circuit conditions
	<ul style="list-style-type: none"> Accel/decel time set too short. 	<ul style="list-style-type: none"> Extend the accel/decel time and operate the motor. 	<ul style="list-style-type: none"> Extend the accel/decel time until overcurrent protective function stops
	<ul style="list-style-type: none"> Load too heavy 	<ul style="list-style-type: none"> Run motor without load Check load conditions 	<ul style="list-style-type: none"> Change V/f pattern. Reduce load.
	<ul style="list-style-type: none"> Power factor correction capacitor connected to Juspeed-F output 	—	Remove
	<ul style="list-style-type: none"> Incorrect V/f pattern selection. 	<ul style="list-style-type: none"> Run motor with frequency set at 5Hz, and V/f pattern selector switch at notch ③ or ⑦ 	<ul style="list-style-type: none"> Select the optimum V/f pattern
 <p>n = 3 times</p>	Overvoltage protection <ul style="list-style-type: none"> Decel time set too short. 	<ul style="list-style-type: none"> Extend the decel time and operate the motor 	<ul style="list-style-type: none"> Extend the decel time until overvoltage protective function stops
 <p>n = 4 times</p>	Undervoltage protection <ul style="list-style-type: none"> Supply voltage too low Momentary power failure (15 ms or more) 	Measure supply voltage with voltmeter	Restart the motor when the measured voltage is correct <ul style="list-style-type: none"> Eliminate the cause of voltage drop
 <p>n = 5 times</p>	<ul style="list-style-type: none"> Ground fault Transistor module damaged. 	Remove all Juspeed-F terminals and check continuity across any one of motor leads and ground with a 500 V megger.	If less than $1M\Omega$, eliminate the cause of ground fault.
 <p>n = 6 times</p>	<ul style="list-style-type: none"> Microcomputer malfunction due to noise 	Check to see if noise source exists at inverter Input/Output.	Prevent noise generation <ul style="list-style-type: none"> Insert a noise filter at inverter primary or secondary side.

Note

- 1 If fault lamp blinks, set RUN/STOP switch to STOP, find the cause, and turn off MCCB and MC
2. If the cause cannot be found, disconnect leads from Juspeed-F and motor

- 3 For any problem which cannot be corrected locally, contact your Yaskawa representative

Measuring Points and Instruments

The measuring points and measuring instruments, when measured at commercial frequency, are shown below. Measured data may differ depending on the instruments and circuit, for Juspeed-F primary and secondary voltage and current include higher harmonic.

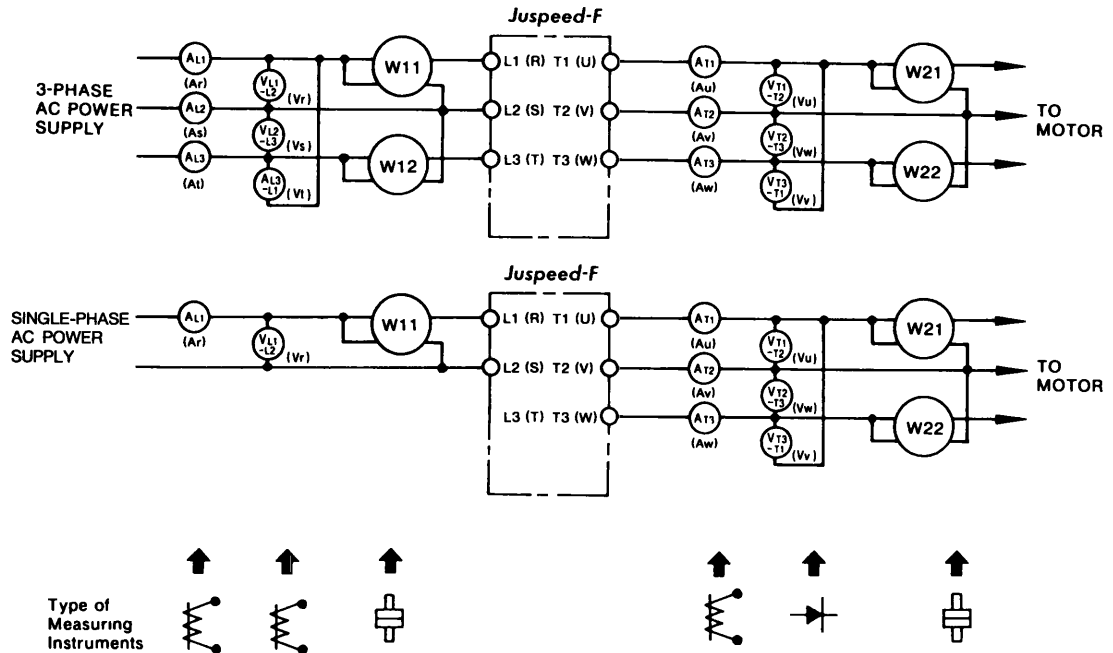

Measuring Points and Instruments

Item	Points	Instrument	Note
Supply Voltage V_1	Across L1-L2 (R-S), L2-L3 (S-T), L3-L1 (T-R); V_{L1-L2} , V_{L2-L3} , V_{L3-L1} (V_R , V_S , V_T)	Moving-iron type	—
Power Supply Current I_1	Line current L1, L2, L3 (R, S, T) A_{L1} , A_{L2} , A_{L3} (A_R , A_S , A_T)	Moving-iron type	—
Power Supply Power* P_1	L1, L2, L3 (R, S, T) and across L1-L2 (R-S), L2-L3 (S-T), L3-L1 (T-R); W_{L1} , W_{L2} , W_{L3} (W_R , W_S , W_T)	Electrodynamometer	$P_1 = W_{11} + W_{12}$
Power Supply Power Factor Pf_1	Calculate from measured supply voltage, supply current, and supply power (For 3-phase) $Pf_1 = \frac{P_2}{\sqrt{3}V_1 \cdot I_1} \times 100 (\%)$	(For single-phase) $Pf_1 = \frac{P_2}{V_1 \cdot I_1} \times 100 (\%)$	
Output Voltage V_2	Across T1-T2 (U-V), T2-T3 (V-W), T3-T1 (W-U); V_{T1-T2} , V_{T2-T3} , V_{T3-T1} (V_U , V_V , V_W)	Rectifier type (YOKOGAWA 2017 or equivalent) Moving-iron type cannot be used.	Difference between each line and max output voltage: 3% or below
Output Current I_2	Line current at T1, T2, T3 (U, V, W); A_{T1} , A_{T2} , A_{T3} (A_U , A_V , A_W)	Moving-iron type	Rated current of Juspeed-F c below ($\pm 10\%$ or below at each line)
Output Current P_2	T1, T2, T3 (U, V, W) and across T1-T2 (U-V), T2-T3 (V-W), T3-T1 (W-U); W_{T1} , W_{T2} , W_{T3} (W_U , W_V , W_W)	Electrodynamometer type, Three identical rating single-phase meters are used.	$P_2 = W_{12} + W_{12}$
Output Power Factor Pf_2	Calculated same as power factor on supply side. (For 3-phase) $Pf_2 = \frac{P_2}{\sqrt{3}V_2 \cdot I_2} \times 100 (\%)$	(For single-phase) $Pf_2 = \frac{P_2}{V_2 \cdot I_2} \times 100 (\%)$	

Juspeed-F S₂ Ratings and Specifications

200v CLASS

Model CIMR-	Analog	G04AS ₂	G08AS ₂	G15AS ₂	G22AS ₂	G37AS ₂	04AS ₂	08AS ₂	15AS ₂	22AS ₂	37AS ₂										
Max Motor Output		3/4HP	1HP	2HP	3HP	5HP	0.4kW	0.75kW	1.5kW	2.2kW	3.7kW										
Rated Capacity		1kVA	1.5kVA	2.5kVA	3.5kVA	6kVA	1kVA	1.5kVA	2.5kVA	3.5kVA	6kVA										
Rated Current*		3A(3A)*	4.2A(2.0A)*	7.5A(3.5A)*	9.7A(5A)*	16.7A(8.5A)*	3A(3A)*	4.5A	7.5A	10.5A	17.5A										
Input Power Supply	208/230V ±10%						200/220V ±10%														
	3-phase, at 50/60 Hz, ±5%																				
Max Output Voltage†	208/230V [†] ±10%						200/220V [†] ±10%														
	3-phase																				
Control Method	Sinusoidal sine wave PWM																				
Output Frequency Range	5 to 120Hz (5 to 360Hz available)																				
Frequency Resolution	0.25Hz (5 to 60Hz), 0.5Hz (5 to 120Hz)																				
Frequency Accuracy	±0.5% (-10 to +40°C, +14 to +104°F)																				
Allowable Overload Capacity	150% for two minutes																				
Accel/Decel Time‡	0.35 to 26 sec (16 selections available independently of accel/decel)																				
Braking	Braking by charging capacitor and discharging resistor, or DC injection braking for less than 3Hz (100% braking torque)																				
Approx. Weight	5.07 lb	5.29 lb	5.73 lb	11.46 lb	12.34 lb	2.3kg	2.4kg	2.6kg	5.2kg	5.6kg											
Munsell Notation	7.5PB 2/4 (Purplish blue), dull finish																				
Input Signal	Run and Stop	Forward/reverse changing or forward/reverse individual operation can be selected																			
	Forward/Reverse Run																				
	Frequency Setting											Analog Frequency setting pot or any of 0 to 0V, 1 to 5V, 4 to 20mA selectable									
	Multi-speed											7 steps (5, 10, 20, 30, 40, 50 and 60Hz) by contact signal									
	Reset											Reset command of protective function by 1NO contact									
Protective Functions	Instantaneous Power Loss	Protective circuit functions if power loss is detected																			
	Undervoltage	Stopped at 170V or less																			
	Overcurrent	Stopped by overcurrent caused by short circuit and/or ground fault before operation																			
	Overvoltage	Stopped by overvoltage when regeneration																			
Environmental Conditions	Location	Indoor (free from corrosive gases and dust)																			
	Ambient Temperature	-10 to +40°C (+14 to +104°F) for enclosed type -10 to +50°C (+14 to +122°F) for open chassis type																			
	Humidity	95% max relative (non-condensing)																			
	Elevation	3300 feet max (1000 meters)																			
	Vibration	0.5G max																			

* Parenthesized values are for single-phase power input.

† Inverter input voltage and output voltage equalize
208V output at 208V input and 230V output at 230V input

‡ 0.35 sec or less available as an option

CAUTIONS :

1. WHEN USING SINGLE-PHASE POWER SUPPLY, BE SURE TO CONNECT TERMINALS TO L₁ AND L₂. FAILURE TO OBSERVE THIS CAUTION MAY RESULT IN RAPID FAILURE OF THE UNIT.
2. OPERATOR'S SWITCH CAN BE INSTALLED SEPARATE FROM INVERTER PROPER. FOR SEPARATION, CONTACT YASKAWA REPRESENTATIVE.
3. NOISE FILTER TO ELIMINATE RADIO WAVE INTERFERENCE IS AVAILABLE ON REQUEST AS AN OPTION.
4. FOR EXCESSIVELY HIGH LOAD INERTIA OR REPEATED RAPID DECELERATION, BUILT-IN BRAKING RESISTOR CAPACITY MAY NOT BE SUFFICIENT FOR THIS APPLICATION, CONTACT YOUR YASKAWA REPRESENTATIVE.
5. WHEN SINGLE-PHASE POWER SUPPLY IS APPLIED, THE MODELS RATED 0.75kW (1HP) OR OVER MUST BE OPERATED AT HALF OF THE RATED CURRENT.

MODEL DESIGNATION

CIMR- [] [0] [8] [] S₂ - []

Inverter Voltage
G: 208/230V
Blank 200/220V
F: 400V class
J: 100V class

Max Applicable Motor Output
04: 3/4HP(0.4kW)
to to
75: 10HP(7.5kW)

Frequency Setting
A. Analog C Digital

Enclosures
0: Enclosed type with operator
1: Open chassis type without operator
2: Enclosed type without operator

Product series
S₂ Standard
P Low noise

Juspeed-F S₂ Ratings and Specifications (Cont'd)
 400V,100V CLASS LOW NOISE SERIES

Item	Series	400V						100V		Low Noise		
	Command	Analog						Analog		Analog		
	Model	CIMR-F04AS ₂	CIMR-F08AS ₂	CIMR-F15AS ₂	CIMR-F22AS ₂	CIMR-F37AS ₂	CIMR-F55AS ₂	CIMR-F75AS ₂	CIMR-J04AS ₂ -1	CIMR-J08AS ₂ -1	CIMR-O8AP-1	CIMR-22AP-1
Max Motor Output		3/4HP 0.4kW	1HP 0.75kW	2HP 1.5kW	3HP 2.2kW	5HP 3.7kW	7.3HP 5.5kW	10HP 7.5kW	3/4HP 0.4kW	1HP 0.75kW	1HP 0.75kW	3HP 2.2kW
Rated Capacity		1kVA	1.5kVA	2.5kVA	3.5kVA	6kVA	9kVA	12kVA	1kVA	1.5kVA	1.5kVA	3.5kVA
Rated Current		1.5A	2.3A	4.0A	5.5A	9.0A	11.0A	17.5A	3.0A	4.0A	4.5A	10.5A
Input Power Supply		3-phase 380/400/440V (±10%) at 50/60Hz (±5%) 3-phase 460V (±10%) at 60Hz (±5%)						Single phase 110/115V (±10%) at 50/60Hz (±5%)		3-phase 200V(±10%) at 50/60Hz(±5%) 3-phase 200/220V(±10%) at 60Hz(±5%)		
Max Output Voltage		3-phase 380/400/440/460V						3-phase 200/210V		3-phase 180/200V		
Control Method		Sinusoidal sine wave PWM										
Output Frequency Range		5 to 120Hz(5 to 360Hz available)										
Frequency Resolution		0.25Hz(5 to 60Hz), 0.5Hz(5 to 120Hz)										
Frequency Accuracy		±0.5%(-10 to +40°C, +14 to +104°F)										
Allowable Overload Capacity		150% for two minutes										
Accel/Decel Time		0.35* to 26 sec(16 selections available independently of accel/decel)										
Braking		Braking by charging capacitor and discharging resistor, or dynamic braking for less than 3Hz(100% braking torque)										
Approx Weight		5.07 lb 2.3kg	5.29 lb 2.4kg	5.73 lb 2.6kg	11.46 lb 5.2kg	12.34 lb 5.6kg	18.73 lb 8.5kg	19.83 lb 9kg	3.53 lb 1.6kg	3.97 lb 1.8kg	5.07 lb 2.3kg	8.81 lb 4.0kg
Munsell Notation		N2.0										
Construction		Enclosed with operator, Enclosed without operator, Open chassis						Open chassis				
Input Signal	Run and Stop	Forward/reverse changing or forward reverse individual operation can be selected										
	Forward/Reverse Run											
	Frequency Setting	Analog Frequency setting pot or any of 0 to 10V, 1 to 5V, 4 to 20mA selectable										
	Multi-speed	7 steps(5, 10, 20, 30, 40, 50, and 60Hz) by contact signal										
	Reset	Reset command of protective function by INO contact										
Output Signal	Run-State	The switch to select the frequency synchronization output switch or output signal during operation										
	Output Signal	The output signal is output by the open collector (Vcc max=35V, Ic max=50mA)										
Protective Functions	Instantaneous Power Loss	Protective circuit functions if power loss is detected										
	Undervoltage	Stopped at input voltage 330V or less						Stopped at input voltage 80V or less		Stopped at input voltage 170V or less		
	Overcurrent	Stopped by overcurrent caused by short circuit and/or ground fault before operation †										
	Overvoltage	Stopped by overvoltage when regeneration.										
Environmental Conditions	Location	Indoor(free from corrosive gases and dust)										
	Ambient Temperature	-10 to +40°C(+14 to +104°F)for enclosed type						-10 to +50°C(+14 to +122°F)				
		-10 to +50°C(+14 to +122°F)for open chassis type										
	Humidity	95% max relative (non-condensing)										
	Elevation	3300 feet max(1000 meters)										
Vibration	0.5G max											

*0.35 sec or less available as an option

† For models F37AS₂, F55AS₂, and F75AS₂ detection possible

at grounding during operation

*NEMA 1 specification for the enclosed

CAUTIONS:

- WHEN USING SINGLE-PHASE POWER SUPPLY, BE SURE TO CONNECT TERMINALS TO L₁ AND L₂. FAILURE TO OBSERVE THIS CAUTION MAY RESULT IN RAPID FAILURE OF THE UNIT.
- OPERATOR'S SWITCH CAN BE INSTALLED SEPARATE FROM INVERTER PROPER FOR SEPARATION, CONTACT YASKAWA REPRESENTATIVE.
- NOISE FILTER TO ELIMINATE RADIO WAVE INTERFERENCE IS AVAILABLE ON REQUEST AS AN OPTION.
- FOR EXCESSIVELY HIGH LOAD INERTIA OR REPEATED RAPID DECELERATION, BUILT-IN BRAKING RESISTOR CAPACITY MAY NOT BE SUFFICIENT FOR THIS APPLICATION, CONTACT YOUR YASKAWA REPRESENTATIVE.

Manufacturer & Distributor*Pushing High Performance Beyond the Limit***YE DRIVE Co., Ltd.****IIZUKA PLANT** 31-Yoshikita, Iizuka City, Fukuoka, 820 Japan
Phone (0948) 24-7600 Fax (0948) 24-7316**TOKYO SALES DIVISION** C/O YASKAWA Electric Mfg. Co., Ltd. Tokyo Office
Ohtemachi Bldg. 1-6-1 Ohtemachi, Chiyoda-ku, Tokyo, 100 Japan
Phone (03) 3284-9077 Fax (03) 3284-9383**OSAKA SALES DIVISION** C/O YASKAWA Electric Mfg. Co., Ltd. Osaka Office
Osaka Daiichi Seimei Bldg., 1-8-17 Umeda, Kita-ku, Osaka, 530 Japan
Phone (06) 346-4580 Fax (06) 346-4565**NAGOYA SALES DIVISION** C/O YASKAWA Electric Mfg. Co., Ltd. Nagoya Office
Horiuchi Bldg. 3-25-9 Meieki, Nakamura-ku, Nagoya, 450 Japan
Phone (052) 581-2346 Fax (052) 581-2359**KYUSHU SALES DIVISION** C/O YASKAWA Electric Mfg. Co., Ltd. Kyushu Office
Chiyoda Seimei Fukuoka Bldg. 1-9-17 Tenjin, Fukuoka, 810 Japan
Phone (092) 714-5075 Fax (092) 714-5799*A Better Tomorrow for Industry through Automation***YASKAWA Electric Mfg. Co., Ltd.****TOKYO OFFICE** Ohtemachi Bldg. 1-6-1 Ohtemachi, Chiyoda-ku, Tokyo, 100 Japan
Phone (03) 3284-9111, -9415 Telex YASKAWA J33530 Fax (03) 3284-9034**SEOUL OFFICE** Seoul Center Bldg. 91-1, So Kong-Dong, Chung-ku, Seoul, Korea
Phone (02) 776-7844 Fax (02) 753-2639**SINGAPORE OFFICE** CPF Bldg. 79 Robinson Road No. 24-03, Singapore 0106
Phone 2217530 Telex (87) 24890 YASKAWA RS Fax (65) 224-5854**TAIPEI OFFICE** Union Commercial Bldg., 137, Nanking East Road, Sec. 2, Taipei, Taiwan
Phone (02) 507-7065, -7732 Fax (02) 506-3837**YASKAWA ELECTRIC AMERICA, INC. : SUBSIDIARY****Chicago Office (Head Office)** 3160 MacArthur Blvd., Northbrook, Illinois 60062-1917, U.S.A.
Phone (708) 291-2340, 291-2348 Telex (230) 270197 YSKW YSNC NBRK Fax (708) 498-2430, 480-9731**Los Angeles Office** 734 Lincoln Way, Garden Grove, California 92641, U.S.A.
Phone (714) 894-5911 Telex (230) 678396 YASKAWAUS TSTN Fax (714) 894-3258**New Jersey Office** 30 Two Bridges Road, Fairfield, New Jersey 07006, U.S.A.
Phone (201) 575-5940 Fax (201) 575-5947**YASKAWA ELECTRIC EUROPE GmbH : SUBSIDIARY****Niederhochstadter Straße 71 73, W 6242 Kronberg-Oberhochstadt Germany**
Phone (06173) 640071, 640072, 640073 Telex 415660 YASE D Fax (06173) 68421**YASKAWA ELÉTRICO DO BRASIL COMÉRCIO LTDA. : SUBSIDIARY****Av. Brig. Faria Lima, 1664-cj 721/724, Pinheiros, São Paulo-SP, Brasil CEP-01452**
Phone (011) 813-3933, 813-3694 Telex (011) 82869 YSKW BR Fax (011) 815-8795*Due to ongoing product modification/improvement, data subject to change without notice.*